

ADIT
2 Dale Road
MATLOCK, Derbyshire, DE4 3LT
Web: www.AdiTrading.com

Head Office: 01629 561 90
Northern Sales: 07702 871 588
Southern Sales: 07790 033 612
London Sales: 07790 033 613

Intelligent gastro racks

"The innovative FRIES rack system sets the standard."

With its complete rack system, FRIES offers bistros, bars, cafés and restaurants an all-round solution for storing, transporting and washing glasses and cups.

Whatever your requirements are – we definitely have the right rack for you.



Advantages

Rack system L 400

Page 3



Rack system L 400

for storage, transport and washing

Page 4 - 5



Logistics and accessories

for transport and storage

Page 5



Rack system R 400

the all-round solution for washing

Page 6 - 7

Advantages L 400 rack system

Available rack widths

390 x 390 mm
396 x 396 mm

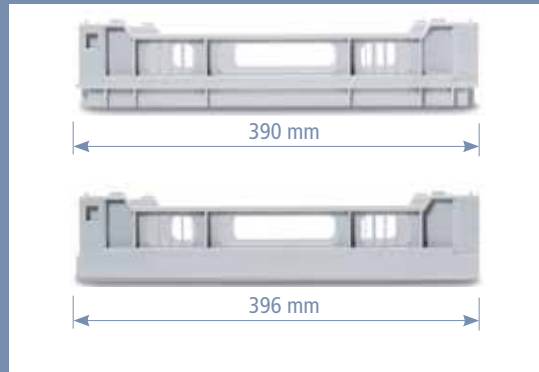

Tilting position

The glasses and cups can be tilted using the terrace insert. This enables even better cleaning results.

Colour-coded corner profiles



Corner profiles are available in various colours to quickly match the glass and the suitable rack.

Easy rack measurement



Extra service: Rack measurement with the FRIES measuring chart

The FRIES measuring chart helps you to find the right rack type easily. Using the measuring chart, the suitable compartment division and height of the glasses can be identified easily.



Measuring chart
Request our measuring chart here!

www.fries-kt.com

Rack system L 400

"The ideal solution for cleaning, storage and transport."

The 400 x 400 mm rack system is suitable for glasses up to a height of 264 mm for undercounter machines. The rack compartment is adjusted to the glass diameter and glass height in each case. The FRIES rack system L 400 offers versatile use in cleaning, storage and transport. Optional colour-coding makes handling even easier.

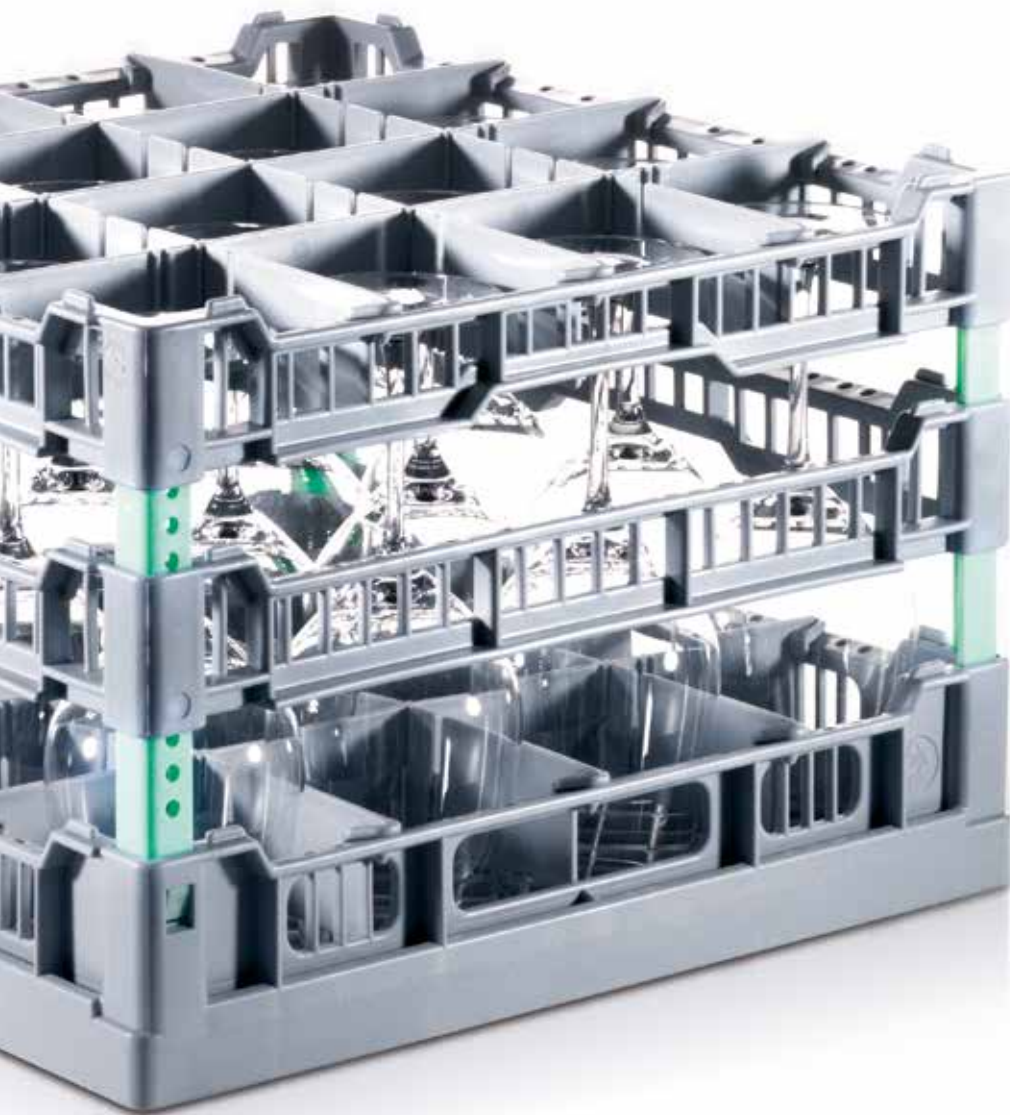

Rack system L 400 ... at a glance

- » stackable
- » light-weight
- » easy checking of rack contents
- » good carrying comfort
- » less glass breakage through customisation
- » tilting of glasses as option
- » suitable for transport on Euro pallets

Rack system L 400

Rack types for glass heights up to a maximum of:

65 mm (LA)



120, 132, 144, 156, 168, 180 (LB)



192, 204, 216, 228, 240 mm (LC)



240, 252, 264 mm (LD3)



Compartments

9 compartments
(3 x 3)

Compartment size:
115 x 115 mm

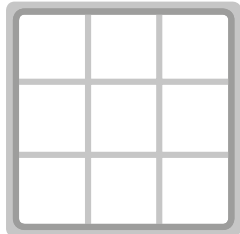

12 compartments
(3 x 4)

Compartment size: 115 x
88 mm

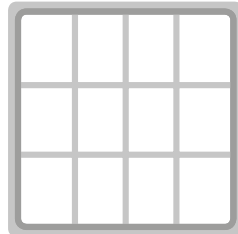

16 compartments
(4 x 4)

Compartment size:
88 x 88 mm

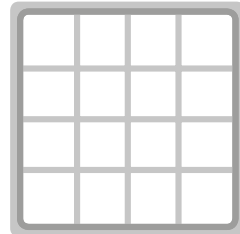

20 compartments
(4 x 5)

Compartment size:
88 x 68 mm

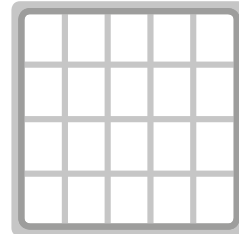

25 compartments
(5 x 5)

Compartment size:
68 x 68 mm

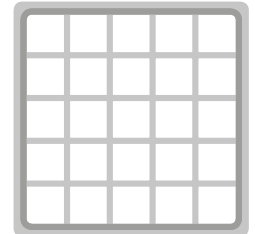

Accessories for the L 400 rack system

Drip tray (AW 400)
suitable for the counter



Cover (ABH 400)
Height 1.60 m
for protecting the glasses during
storage and transport

Platform cart with drip tray
(ROL 400 + AW 400)
ROL 400 with removable
drip tray AW 400



Bistro racks R 350-400

Rack widths bistro racks:

350 x 350 mm
 390 x 390 mm
 396 x 396 mm
 400 x 400 mm

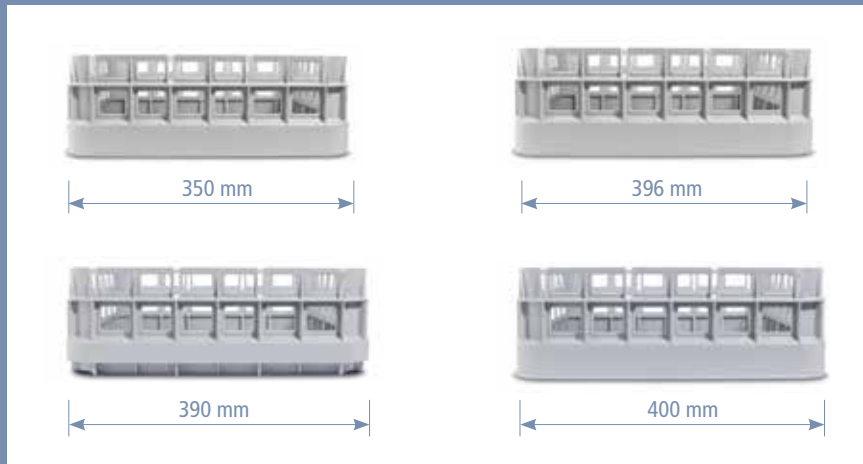

Rack types

Bistro rack (R 350)

Rack width: 350 mm
 Internal height: 105 mm



Bistro rack (R 390, R 396, R 400)

R 390: Rack width: 390 mm
 R 396: Rack width: 396 mm
 R 400: Rack width: 400 mm
 Internal height: 125 mm



Accessories

Glasrelax (GR 400)

Terrace insert for tilting the glasses (for R 390-400 only)



Plate insert (PI 400, PI 350)

Plate inserts for bistro racks
 PI 400 for 9 plates, PI 350 for 8 plates



Cutlery holder (CBS)



Examples of use and rack sets

R 390-1GR 400

R390 equipped with a GR 400 insert



R 400 + PI 400

R 400 equipped with a PI 400 insert



PI 400

R 400 equipped with two PI 400 inserts



R 390-3GR 400

R390 equipped with 3 GR 400



R396-4GR 400

R396 equipped with 4 GR 400



Bistro set 396

2 × R 396



4 × GR 400



1 × PI 400



1 × CBS



Contents

2 R 396 bistro racks, 4 GR 400 glass inserts,
1 PI 400 plate insert, 1 CBS cutlery holder;
also available as bistro set 390 + 400

Bistro set 350

2 × R 350



1 × PI 350



1 × CBS



Contents

2 R 350 bistro racks, 1 PI 350 glass insert
and 1 CBS cutlery holder



Rack systems 400

All advantages of the
FRIES rack systems

www.fries-kt.com

Rack systems 400

The small all-round rack for various items or the rack system with glass compartments for storage, transport and cleaning.

No one offers more options than us!



Rack systems 400 x 400
More information on the rack systems 400
www.fries-kt.com

Have you seen this?

Learn more about our large range of products.



Rack system 500 x 500
for gastronomic applications

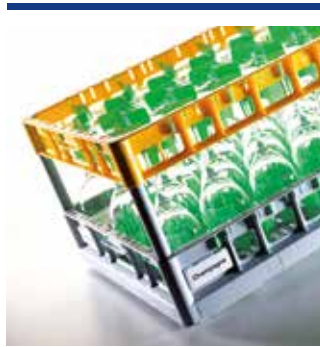

Rack system 600 x 400
for logistic and catering applications



Rack system 600 x 500
for large hood-type and rack conveyor machines



Gastro & catering
Dishes transport box and party plates



FRIES Kunststofftechnik GmbH

Schützenstraße 19, 6832 Sulz, Austria
Phone: +43(0)5522 4935 201, Fax: + 43(0)5522 4935 209
info@fries.at, www.fries-kt.com



Packaging



Gastro



Industry racks



Moulding